

Date:	Approved:
Type:	
Fixture:	
Project:	

Full-Body LED High Bay LS-FHB-V2

STANDARD



FEATURES

- Available in 4000k (neutral white) and 5000k (cool white) color temperatures.*
- Long-life LEDs provide 122,000 hours of operation with at least 70% of initial lumen output (L₇₀).**
- Delivers from 12,193 lumens (140 lumens per watt, LPW) to 60,629 lumens (142 LPW).*
- 0-10vdc dimming drivers are standard.
- Power factor > 0.90.
- Total harmonic distortion < 20%.
- Color rendering index > 80.
- Painted steel housings are standard.
- Chain-mount kits (includes v-hooks and 1/8" thick, 1-meter long chain) are standard.
- Accessories include lenses (clear & diffused), wire-guard kits, surface-mounting kits, pendant-mounting kits, and cable-mounting kits.
- Easy installation in new construction or retrofit.

* Contact factory for other color temperatures and lumen packages.

** L₇₀ hours are IES TM-21-11 calculated hours.



WARRANTY & LISTINGS

- cULus listed for damp locations in ambient temperatures from -20°C to 50°C (-4°F to 122°F).
- DLC 5.0 premium approved.
- Flicker-free per IEEE1789-2015 (low risk of adverse effects of flicker at 100% light output level).
- Complies with RoHS (Restriction on Hazardous Substances) requirements.
- Complies with FCC Part 15, class A.
- Complies with IEEE C.62.41-1991, input transient protection (2.5kV).
- 5-year warranty of all electronics and housing.

MOUNTING OPTIONS

- Chain mounting with V-hooks is standard.
- Optional surface mounting kits provides attachment to flat ceilings.*
- Optional pendant mounting kits provides pendant attachment to junction boxes.
- Optional cable mounting kits provide suspension at two lengths (i.e., 3 & 5 meters).

* Not compatible with 347-480V models or emergency drivers.

ORDERING INFORMATION

Example: LS-FHB180-5K-MVDIM-V2-OS-EM20

Model	Color Temperature		Voltage		Series	Occupancy Sensor ^{1,2}		Emergency Driver ^{3,4,5}	
	4K	5000k	MVDIM	120-277V		OS	Passive infrared	EM12	1200 lumens
LS-FHB90	4K	4000k	MVDIM	120-277V	V2	OS	Passive infrared	EM12	1200 lumens
LS-FHB135	5K	5000k	UNC	347-480V		ODS	Microwave	EM16	1600 lumens
LS-FHB180						Blank	No occupancy sensor	EM20	2000 lumens
LS-FHB215								EM24	2400 lumens
LS-FHB265								EC12	1200 lumens
LS-FHB320								EC16	1600 lumens
LS-FHB425								EC20	2000 lumens
								EC24	2400 lumens
								Blank	No emergency driver

¹ Sensors available for 120-277V models only.

² Contact factory for other sensors.

³ Emergency drivers available for 120-277V models only.

⁴ See list of emergency drivers (page 2).

⁵ EC emergency drivers are California Energy Commission (CEC) listed.

Compatible Emergency Drivers

Emergency Driver Part Number	EM12 / EC12		EM16 / EC16		EM20 / EC20		EM24 / EC24		Runtime
Model	Watts	EM Lumens	Watts	EM Lumens	Watts	EM Lumens	Watts	EM Lumens	
LS-FHB90	7.8	1092	10.7	1498	13.7	1918	17.0	2380	90 MINS.
LS-FHB135	7.8	1084	10.7	1487	13.7	1904	17.0	2363	
LS-FHB180	7.8	1092	10.7	1498	13.7	1918	17.0	2380	
LS-FHB215	7.8	1100	10.7	1509	13.7	1932	17.0	2397	
LS-FHB265	7.8	1100	10.7	1509	13.7	1932	17.0	2397	
LS-FHB320	7.8	1076	10.7	1477	13.7	1891	17.0	2346	
LS-FHB425	7.8	1084	10.7	1487	13.7	1904	17.0	2363	

Accessories

Lens

- LS-FHB-CRLENS-12X23 = Clear lens – 90W, 135W & 180W
- LS-FHB-CRLENS-17X23 = Clear lens – 215W
- LS-FHB-CRLENS-12X45 = Clear lens – 265W & 320W
- LS-FHB-CRLENS-17X45 = Clear lens – 425W
- LS-FHB-DIFLENS-12X23 = Diffuse lens – 90W, 135W & 180W
- LS-FHB-DIFLENS-17X23 = Diffuse lens – 215W
- LS-FHB-DIFLENS-12X45 = Diffuse lens – 265W & 320W
- LS-FHB-DIFLENS-17X45 = Diffuse lens – 425W

Wire Guard

- LS-FHB-WG-12X23 = Wire-guard kit – 90W, 135W & 180W
- LS-FHB-WG-17X23 = Wire-guard kit – 215W
- LS-FHB-WG-12X45 = Wire-guard kit – 265W & 320W
- LS-FHB-WG-17X45 = Wire-guard kit – 425W

Mounting Options

- LS-FHB-SMK-12.625WIDE = Surface-mount kit – 90W, 135W, 180W, 265W & 320W
- LS-FHB-SMK-17.25WIDE = Surface-mount kit – 215W & 425W
- LS-FHB-PMK = Pendant-mount kit – 90W, 135W, 180W, 265W, 320W, & 425W
- LS-FHB-PMK8 = Pendant-mount kit – 215W
- LS-FHB-CMK3 = Cable-mounting kit, 3 meters long
- LS-FHB-CMK5 = Cable-mounting kit, 5 meters long

ELECTRICAL DATA

Model	Color Temp.	CRI ¹	Luminaire Lumens	Luminaire Watts	Lumens/Watt	Input Voltage ²	Input Current (A)			Power Factor	THD ³	L ₇₀ Hours ⁴
							120V	240V	277V			
LS-FHB90-4K-MVDIM-V2	4000k	>80	12,193	87	140	120-277	0.73	0.36	0.31	>90%	<20%	122,000
LS-FHB90-5K-MVDIM-V2	5000k	>80	12,394	87	142	120-277	0.73	0.36	0.31	>90%	<20%	122,000
LS-FHB135-4K-MVDIM-V2	4000k	>80	18,401	132	139	120-277	1.10	0.55	0.48	>90%	<20%	122,000
LS-FHB135-5K-MVDIM-V2	5000k	>80	18,564	132	141	120-277	1.10	0.55	0.48	>90%	<20%	122,000
LS-FHB180-4K-MVDIM-V2	4000k	>80	24,457	175	140	120-277	1.46	0.73	0.63	>90%	<20%	122,000
LS-FHB180-5K-MVDIM-V2	5000k	>80	24,603	175	141	120-277	1.46	0.73	0.63	>90%	<20%	122,000
LS-FHB215-4K-MVDIM-V2	4000k	>80	29,929	213	141	120-277	1.78	0.89	0.77	>90%	<20%	122,000
LS-FHB215-5K-MVDIM-V2	5000k	>80	30,356	213	143	120-277	1.78	0.89	0.77	>90%	<20%	122,000
LS-FHB265-4K-MVDIM-V2	4000k	>80	37,590	267	141	120-277	2.23	1.11	0.96	>90%	<20%	122,000
LS-FHB265-5K-MVDIM-V2	5000k	>80	37,996	267	142	120-277	2.23	1.11	0.96	>90%	<20%	122,000
LS-FHB320-4K-MVDIM-V2	4000k	>80	44,235	320	138	120-277	2.67	1.33	1.16	>90%	<20%	122,000
LS-FHB320-5K-MVDIM-V2	5000k	>80	44,460	320	139	120-277	2.67	1.33	1.16	>90%	<20%	122,000
LS-FHB425-4K-MVDIM-V2	4000k	>80	59,278	428	139	120-277	3.57	1.78	1.55	>90%	<20%	122,000
LS-FHB425-5K-MVDIM-V2	5000k	>80	60,629	428	142	120-277	3.57	1.78	1.55	>90%	<20%	122,000

¹ Color rendering index.

² All 50-60Hz.

³ Total harmonic distortion.

⁴ L₇₀ refers to the number of hours at which lumen output declines to 70% of the initial level. L₇₀ hours are IES TM-21-11 calculated hours.

PHOTOMETRIC DATA

LS-FHB90-5K-MVDIM-V2 (12,394 Lumens)

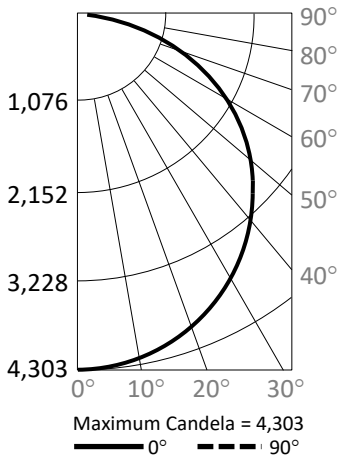

Candlepower Summary

	0°	90°
0°	4,303	4,303
10°	4,274	4,302
20°	4,110	4,154
30°	3,767	3,822
40°	3,305	3,385
50°	2,713	2,841
60°	1,987	2,179
70°	1,176	1,045
80°	385	268
90°	0	0

Zonal Lumen Summary

Zone	Lumens	% Fixture
0° – 10°	406	3.3%
0° – 20°	1,582	12.8%
0° – 30°	3,397	27.4%
0° – 40°	5,614	45.3%
0° – 50°	7,947	64.1%
0° – 60°	10,069	81.2%
0° – 70°	11,644	94.0%
0° – 80°	12,313	99.3%
0° – 90°	12,394	100.0%
90° – 180°	0	0.0%
0° – 180°	12,394	100.0%

Cone of Light

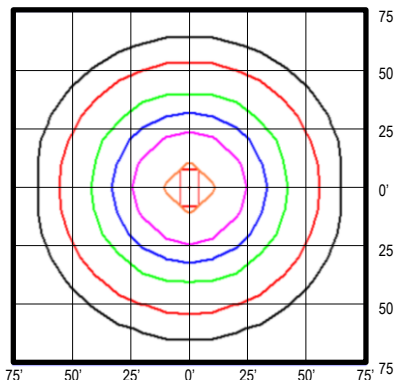
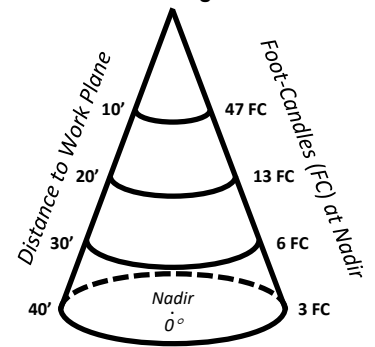

Foot Candles

5.0
2.0
1.0
0.5
0.2
0.1

Notes:

- Isofootcandle plots depict initial foot-candles at grade.
- Gridlines represent units of mounting height of 25 feet.

PHOTOMETRIC DATA

LS-FHB135-5K-MVDIM-V2 (18,564 Lumens)

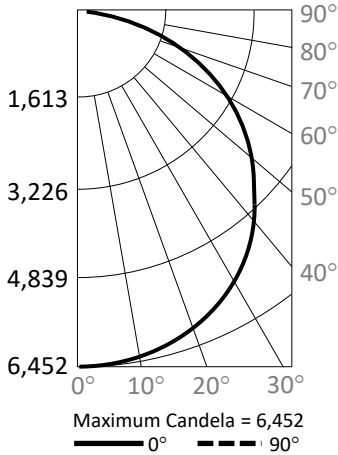

Candlepower Summary

	0°	90°
0°	6,452	6,452
10°	6,398	6,438
20°	6,143	6,215
30°	5,642	5,845
40°	4,948	5,133
50°	4,066	4,265
60°	3,003	3,257
70°	1,772	1,305
80°	580	300
90°	0	0

Zonal Lumen Summary

Zone	Lumens	% Fixture
0° – 10°	610	3.3%
0° – 20°	2,377	12.8%
0° – 30°	5,110	27.5%
0° – 40°	8,470	45.6%
0° – 50°	11,998	64.6%
0° – 60°	15,214	82.0%
0° – 70°	17,465	94.1%
0° – 80°	18,441	99.3%
0° – 90°	18,564	100.0%
90° – 180°	0	0.0%
0° – 180°	18,564	100.0%

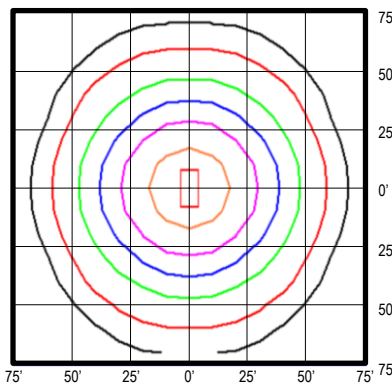
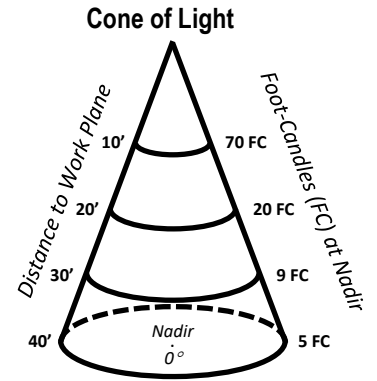

Notes:

- Isofootcandle plots depict initial foot-candles at grade.
- Gridlines represent units of mounting height of 25 feet.

LS-FHB180-5K-MVDIM-V2 (24,603 Lumens)

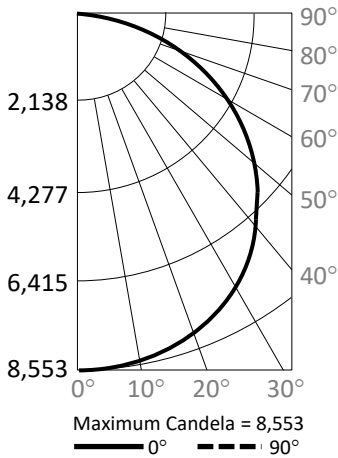

Candlepower Summary

	0°	90°
0°	8,553	8,553
10°	8,487	8,480
20°	8,173	8,255
30°	7,487	7,759
40°	6,581	6,870
50°	5,425	5,678
60°	3,993	3,802
70°	2,383	2,084
80°	808	346
90°	0	0

Zonal Lumen Summary

Zone	Lumens	% Fixture
0° – 10°	809	3.3%
0° – 20°	3,155	12.8%
0° – 30°	6,787	27.6%
0° – 40°	11,259	45.8%
0° – 50°	15,964	64.9%
0° – 60°	20,185	82.0%
0° – 70°	23,093	93.9%
0° – 80°	24,441	99.3%
0° – 90°	24,603	100.0%
90° – 180°	0	0.0%
0° – 180°	24,603	100.0%

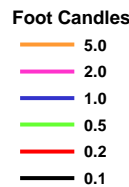
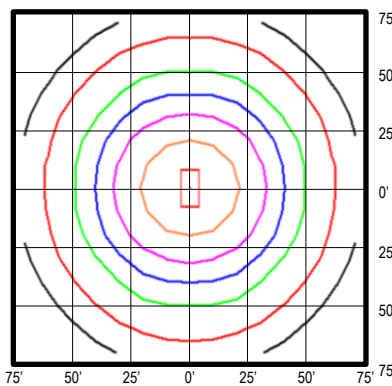
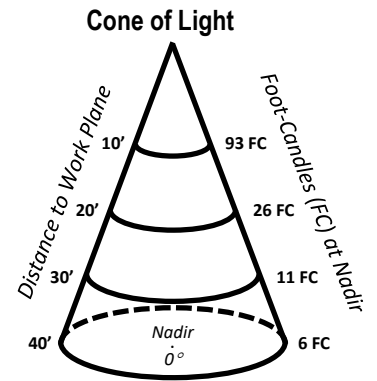

Notes:

- Isofootcandle plots depict initial foot-candles at grade.
- Gridlines represent units of mounting height of 25 feet.

PHOTOMETRIC DATA

LS-FHB215-5K-MVDIM-V2 (30,356 Lumens)

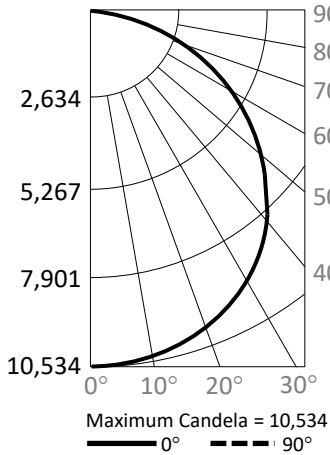

Candlepower Summary		
	0°	90°
0°	10,534	10,534
10°	10,446	10,436
20°	10,036	10,119
30°	9,191	9,493
40°	8,048	8,416
50°	6,605	7,015
60°	4,857	4,897
70°	2,885	2,838
80°	972	560
90°	0	0

Zonal Lumen Summary		
Zone	Lumens	% Fixture
0° - 10°	993	3.3%
0° - 20°	3,870	12.7%
0° - 30°	8,310	27.4%
0° - 40°	13,770	45.4%
0° - 50°	19,513	64.3%
0° - 60°	24,683	81.3%
0° - 70°	28,355	93.4%
0° - 80°	30,118	99.2%
0° - 90°	30,356	100.0%
90° - 180°	0	0.0%
0° - 180°	30,356	100.0%

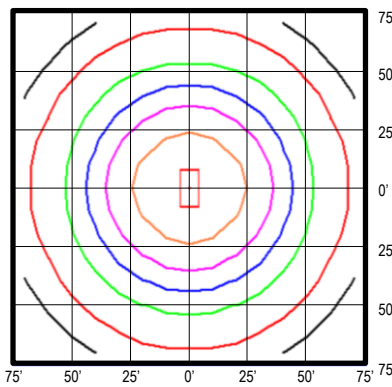
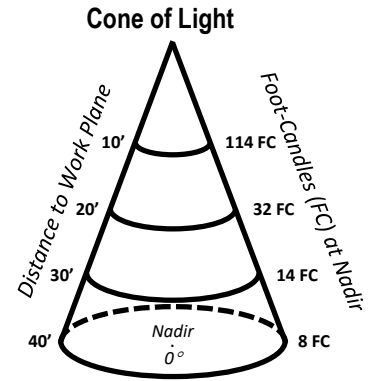

Foot Candles

- 5.0
- 2.0
- 1.0
- 0.5
- 0.2
- 0.1

Notes:

- Isofootcandle plots depict initial foot-candles at grade.
- Gridlines represent units of mounting height of 25 feet.

LS-FHB265-5K-MVDIM-V2 (37,996 Lumens)

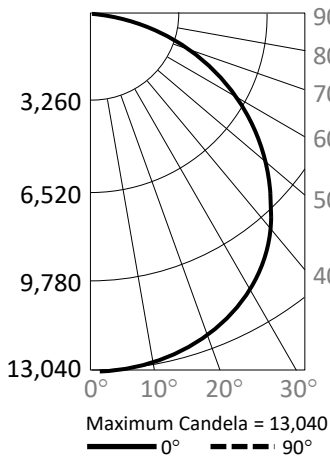

Candlepower Summary		
	0°	90°
0°	13,040	13,040
10°	12,940	12,943
20°	12,450	12,545
30°	11,488	11,728
40°	10,159	10,193
50°	8,449	8,458
60°	6,305	5,687
70°	3,864	2,705
80°	1,376	592
90°	0	0

Zonal Lumen Summary		
Zone	Lumens	% Fixture
0° - 10°	1,234	3.2%
0° - 20°	4,813	12.7%
0° - 30°	10,349	27.2%
0° - 40°	17,160	45.2%
0° - 50°	24,351	64.1%
0° - 60°	30,907	81.3%
0° - 70°	35,544	93.5%
0° - 80°	37,692	99.2%
0° - 90°	37,991	100.0%
90° - 180°	5	0.0%
0° - 180°	37,996	100.0%

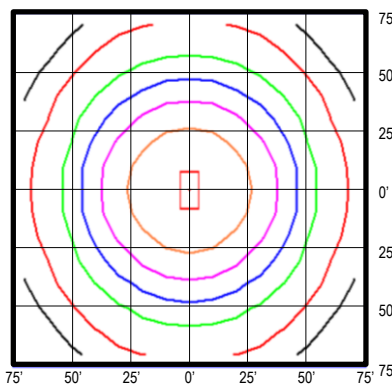
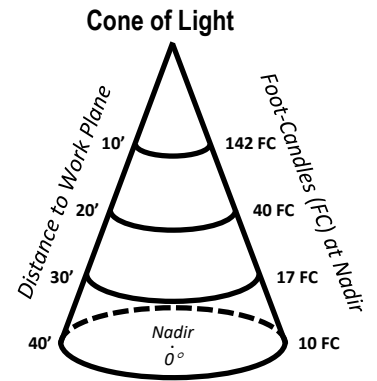

Foot Candles

- 5.0
- 2.0
- 1.0
- 0.5
- 0.2
- 0.1

Notes:

- Isofootcandle plots depict initial foot-candles at grade.
- Gridlines represent units of mounting height of 25 feet.

PHOTOMETRIC DATA

LS-FHB320-5K-MVDIM-V2 (44,460 Lumens)

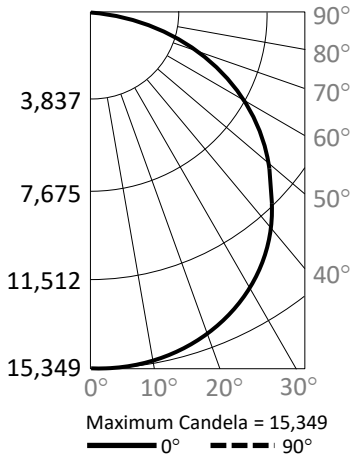

Candlepower Summary		
	0°	90°
0°	15,349	15,349
10°	15,202	15,293
20°	14,607	14,738
30°	13,474	13,773
40°	11,901	12,003
50°	9,818	10,013
60°	7,312	6,602
70°	4,456	3,264
80°	1,578	701
90°	0	0

Zonal Lumen Summary		
Zone	Lumens	% Fixture
0° – 10°	1,453	3.3%
0° – 20°	5,665	12.7%
0° – 30°	12,168	27.4%
0° – 40°	20,153	45.3%
0° – 50°	28,564	64.2%
0° – 60°	36,216	81.5%
0° – 70°	41,604	93.6%
0° – 80°	44,106	99.2%
0° – 90°	44,456	100.0%
90° – 180°	4	0.0%
0° – 180°	44,460	100.0%

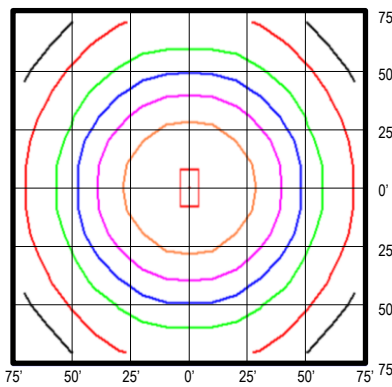
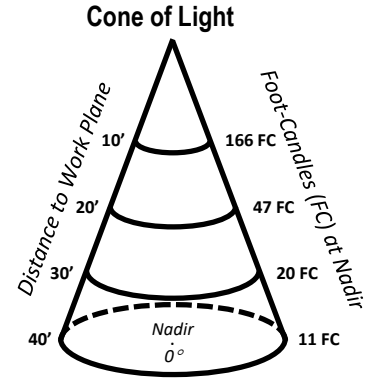

Foot Candles

- 5.0
- 2.0
- 1.0
- 0.5
- 0.2
- 0.1

Notes:

- Isofootcandle plots depict initial foot-candles at grade.
- Gridlines represent units of mounting height of 25 feet.

LS-FHB425-5K-MVDIM-V2 (60,629 Lumens)

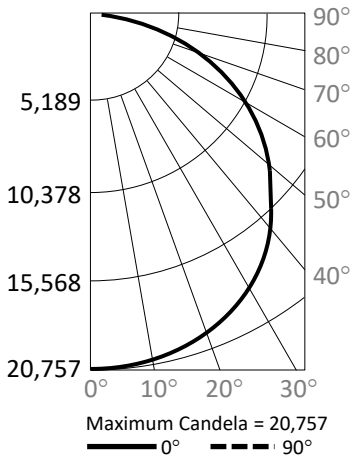

Candlepower Summary		
	0°	90°
0°	20,757	20,757
10°	20,548	20,583
20°	19,742	19,889
30°	18,239	18,567
40°	16,086	16,566
50°	13,307	13,877
60°	9,917	9,531
70°	5,987	5,317
80°	2,089	1,138
90°	0	30

Zonal Lumen Summary		
Zone	Lumens	% Fixture
0° – 10°	1,962	3.2%
0° – 20°	7,645	12.6%
0° – 30°	16,413	27.1%
0° – 40°	27,217	44.9%
0° – 50°	38,652	63.8%
0° – 60°	49,008	80.8%
0° – 70°	56,412	93.0%
0° – 80°	60,036	99.0%
0° – 90°	60,600	100.0%
90° – 180°	29	0.0%
0° – 180°	60,629	100.0%

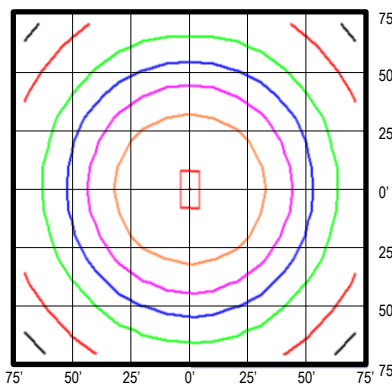
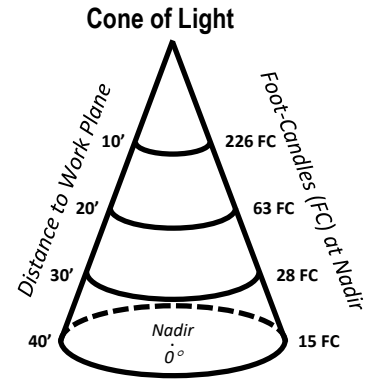

Foot Candles

- 5.0
- 2.0
- 1.0
- 0.5
- 0.2
- 0.1

Notes:

- Isofootcandle plots depict initial foot-candles at grade.
- Gridlines represent units of mounting height of 25 feet.

DIMENSIONS

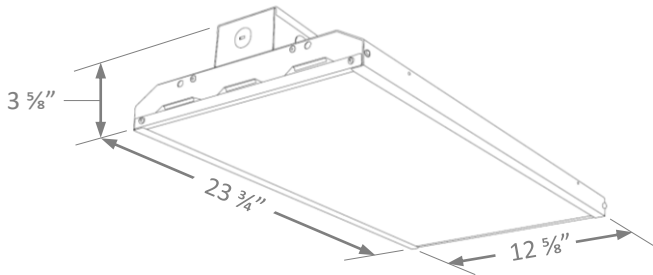

**90 – 180W Models
(9.9 – 11.0 lbs.)**

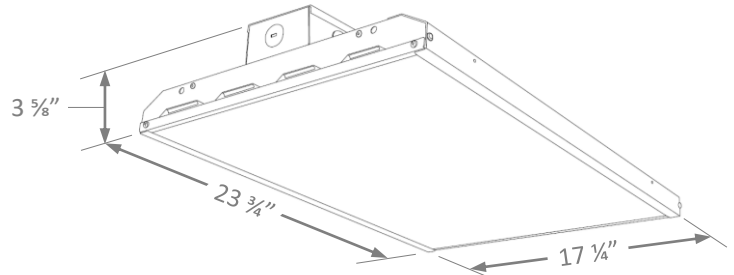

**215W Model
(14.0 lbs.)**

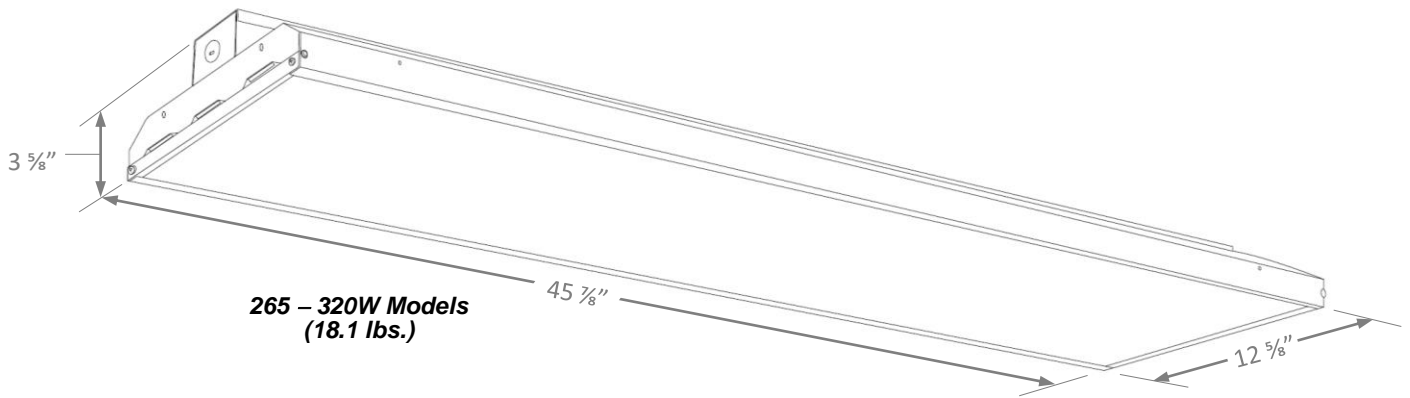

**265 – 320W Models
(18.1 lbs.)**

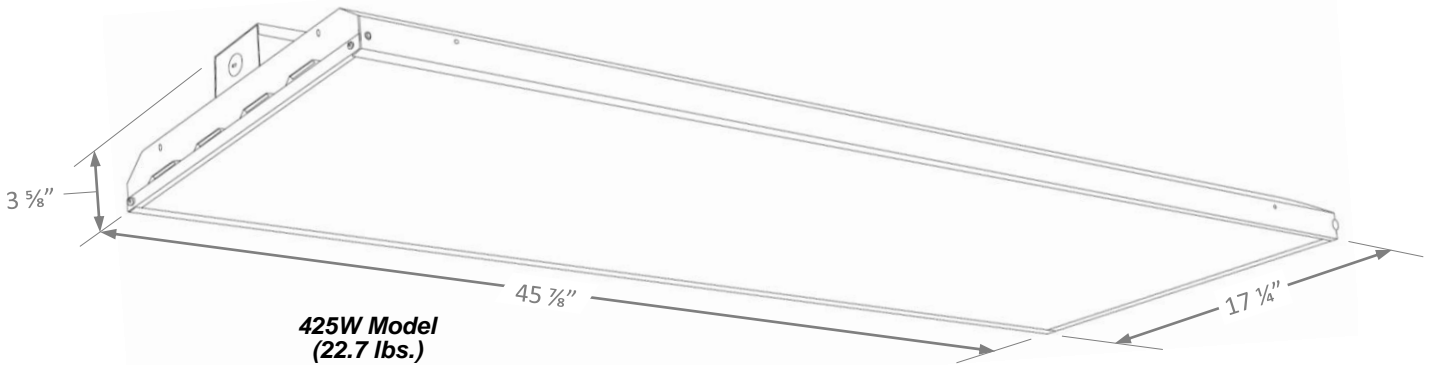

**425W Model
(22.7 lbs.)**